

SSC MOCK TEST - 268 (SOLUTION)

1. (B) Loss of memory is called Amnesia, while loss of movement is called Paralysis.
2. (B) As,

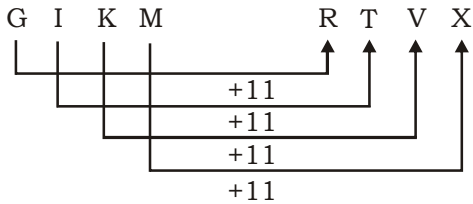

Similarly,

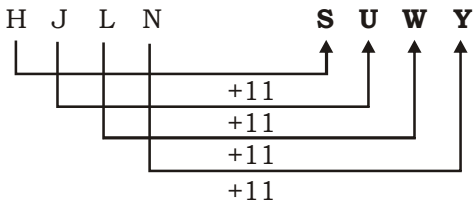

3. (D) As,
 $135 \rightarrow 1^3 3^3 5^3 \rightarrow 127125$
 Similarly,
 $678 \rightarrow 6^3 7^3 8^3 \rightarrow 216343512$
4. (D) (A) $\sqrt{4489} = 67$
 (B) $\sqrt{3025} = 55$
 (C) $\sqrt{625} = 25$
 (D) $\sqrt[3]{1331} = 11$
5. (B) Except oil, others are the product of milk.
6. (C) (A) B $\xleftarrow{\text{opposite}}$ Y
 (B) D $\xleftarrow{\text{opposite}}$ W
 (C) H $\xleftarrow{\text{opposite}}$ S \neq T
 (D) J $\xleftarrow{\text{opposite}}$ Q
7. (D) 3. Training \rightarrow 4. Translate \rightarrow 2. Treadmill \rightarrow 1. Treasure

8. (A)

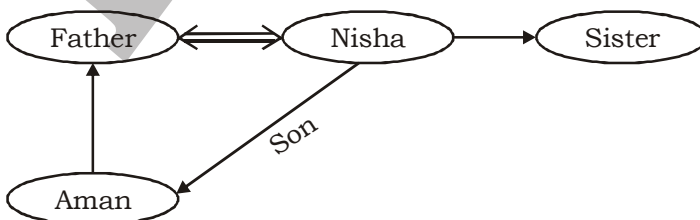

Aman is the son of Nisha.

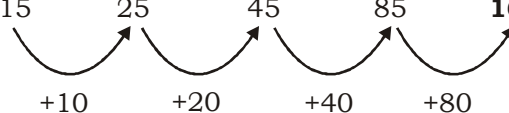
9. (A) $15 \quad 25 \quad 45 \quad 85 \quad 165$

10. (B) $C > A > B$ (i)
 $B > D > E$ (ii)

From (i) and (ii),
 $C > A > B > D > E$
 C is tallest.

11. (D) In these two positions, one of the common face having digit 1 is in the same position. Therefore, 4 is opposite to 5.

12. (A) **From Column Ist,**
 $17 \times (1 + 7 = 8) = 136$
From Column IInd,
 $19 \times (1 + 9 = 10) = 190$
From Column IIIrd,
 $44 \times (4 + 4 = 8) = 352$

13. (D) $18^3 - 18^2 = 5832 - 324 = 5508$
 $25^3 - 25^2 = 15625 - 625 = 15000$

14. (D) As,
 TAPERECORDER $\rightarrow !\# \& @ \wedge @ ? \% \wedge + @ \wedge$
 Similarly,
 REPORTER $\rightarrow \wedge @ \& \% \wedge !$

15. (B)
 16. (B) There are nine triangles in the given figure.
 17. (C) def/efg/fgh/ghi

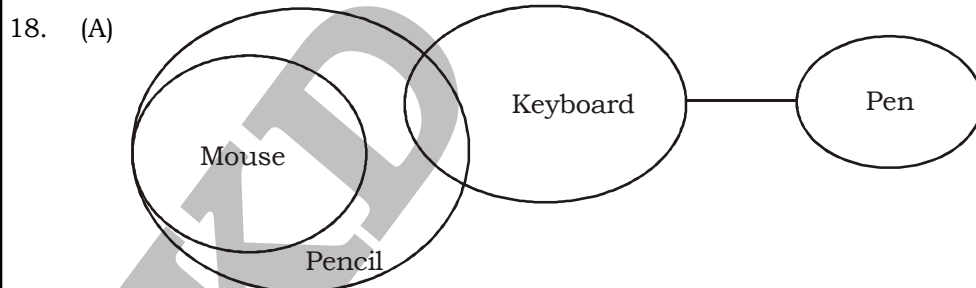

I. True II. False
 Hence, only conclusion I is true.

19. (D) $7V42M56L8S5$
 After putting the value,
 $= 7 - 42 + 56 \div 8 \times 5$
 $= 7 - 42 + 7 \times 5$
 $= 7 - 42 + 35 = 0$

20. (A)

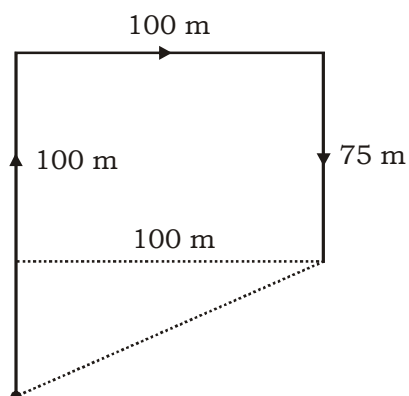

$$\begin{aligned} \text{Required distance} &= \sqrt{100^2 + 75^2} \\ &= \sqrt{10000 + 5625} = \sqrt{15625} \\ &= \sqrt{5 \times 5 \times 5 \times 5 \times 3 \times 3 \times 3 \times 3} = 45\sqrt{5} \text{ m} \end{aligned}$$

21. (C) As,

$$\text{RAM} \rightarrow (18)^2 + (1)^2 + (13)^2 = 494$$

Similarly,

$$\text{SITA} \rightarrow (19)^2 + (9)^2 + (20)^2 + (1)^2 = 843$$

22. (C)

23. (C)

24. (D)

25. (C)

26. (D) The chief male deity was Pashupati Mahadeva (proto-Siv(A)), represented in seals as sitting in a yogic posture on a low throne, and having three faces and two horns. He is surrounded by four animals (elephant, tiger, rhino and buffalo), each facing a different direction and two deers appear at his feet. The chief female deity was Mother Goddess, who has been depicted in various forms. Indus people also worshiped Gods in the form of trees (pipal, etc) and animals (unicorn) etc.

29. (B) The transpiration aspect of evapotranspiration is essentially evaporation of water from plant leaves.

30. (C) Black soil is also known as black lava soil. This soil black in color. It is formed from lava rocks and is rich in clay. Suitable Crops: It is ideal for growing crops such as cotton, sugarcane, tobacco, wheat, millets, and oilseeds.

31. (B) The Constitution of India describes India as the Union of States. ... After independence, India, as it is now, was formed by the decision of the princely states, who decided to join India. Therefore, India is known as Union of States.

32. (C) Soft iron is selected for making the core of an electromagnet because the core is used in a solenoid for the production of the strongest magnetism.

33. (B) This 11.2 km/s is also known as the escape velocity. It works out to roughly 25000 miles per hour.

35. (D) In order to promote road safety and reduce vehicular pollution, Rajasthan Transport department is going to observe a "No Vehicle Day" once a month in 2020. The employees of the transport department are to come to their offices as pedestrians, via bicycles or a public transport.

36. (B) Vitamin D is a hormone the kidneys produce that controls blood calcium concentration and impacts the immune system. It is also known as calcitriol, ergocalciferol, calcidiol and cholecalciferol.

39. (C) International Criminal Police Organisation (INTERPOL) was established in September 7, 1923. It is the largest police organisation in the world. The headquarters of INTERPOL is at Lyons, France (earlier its headquarters was in Paris). It has 190 member-states. It facilitates cross border police cooperation; supports and assists all organisations, authorities and services whose aim is to prevent or combat international crime.
40. (A) 'Gidda' is a recreational folk dance of Punjab. It is performed on all happy occasions by the womenfolk.
44. (C) The functional head of the Government is the Prime Minister
45. (B) The ohm is the standard unit of electrical resistance in the International System of Units (SI).
46. (B) The state government of Madhya Pradesh has formed a dedicated commission to create employment opportunities for the migrant labourers.
47. (C) Bronze contains Cu 90%, Sn (10%) Brass contains Cu (80%), Zn (20%) Gun metal contains Cu (80%), Zn (10%), Sn (10%) Solder is an alloy of Pb (50%) and Sn (50%).
50. (D) Cocaine which is an alkaloid produces numbness and is used as local anaesthetic.
51. (A) Let sides be $15x$, $20x$ and $25x$ respectively.

$$(15x)^2 + (20x)^2 = (25x)^2$$

The triangle is right angled $\frac{1}{2} \times 15x \times 20x = 15000$

$$150x^2 = 15000$$

$$x^2 = 100$$

$$x = 10$$

Perimeter of triangle = $(15 + 20 + 25) \times 10$

$$= (60) \times 10 = 600 \text{ cm}$$

52. (A) $\frac{AB}{AD} = \frac{BC}{CD}$

$$\frac{4a}{7a} = \frac{3b+9}{14b}$$

$$56b = 21b + 63$$

$$35b = 63$$

$$b = \frac{63}{35} = \frac{9}{5}$$

$$a = 2b = 2 \times \frac{9}{5} = \frac{18}{5}$$

53. (B) Volume of the box = $(65 \times 36 \times 80)\text{cm}^3$

Volume of a cake = $(13 \times 18 \times 16)\text{cm}^3$

$$\text{Number of cakes} = \frac{65 \times 36 \times 80}{13 \times 18 \times 16} = 50$$

54. (B)

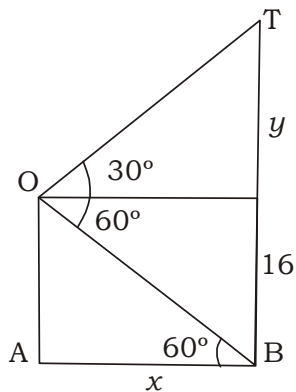

$$\tan 30^\circ = \frac{y}{x} \Rightarrow x = \sqrt{3}y$$

In $\triangle AOB$,

$$\frac{16}{x} = \tan 60^\circ$$

$$16 = \sqrt{3} \times \sqrt{3}y$$

$$\frac{16}{3} = y$$

$$y = 5.33$$

So, height of tower = $(16 + 5.33) = 21.33$ m

55. (D)

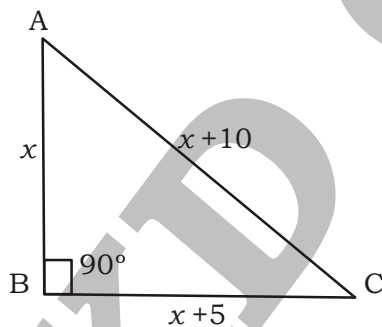

By pythagorouse theorem,

$$(x + 10)^2 = x^2 + (x + 5)^2$$

$$x^2 + 100 + 20x = x^2 + x^2 + 25 + 10x$$

$$x^2 - 10x - 75 = 0$$

$$(x - 15)(x + 5) = 0$$

$$x = 15, x \neq -5$$

Hypotenuse = $x + 10 = 15 + 10 = 25$

56. (B)

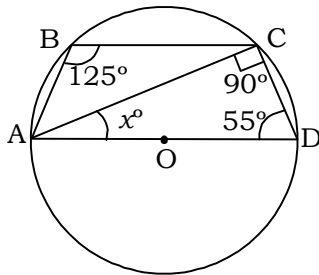

AD is diameter of circle, so $\angle ACD = 90^\circ$

ABCD is a cyclic quadrilateral

So, $\angle ABC + \angle ADC = 180^\circ$

$$125^\circ + \angle ADC = 180^\circ \Rightarrow \angle ADC = 55^\circ$$

In $\triangle ACD$,

$$\angle x + \angle ACD + \angle CDA = 180^\circ$$

$$x + 90 + 55 = 180$$

$$x = 35^\circ$$

57. (D)

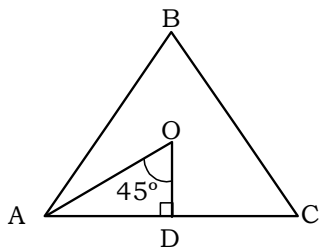

In $\triangle ABC$ and $OD \perp AC$

$$\angle AOD = 45^\circ \text{ \& } \angle ODA = 90^\circ$$

In $\triangle AOD$,

$$\angle OAD + 45^\circ + 90^\circ = 180^\circ$$

$$\angle OAD = 45^\circ$$

$$\angle BAC = 2 \times \angle OAD = 2 \times 45^\circ = 90^\circ$$

58. (C) Centroid = $\left(\frac{1}{3}(x_1 + x_2 + x_3), \frac{1}{3}(y_1 + y_2 + y_3) \right)$

$$= \left(\frac{1}{3}(2 + 8 - 1), \frac{1}{3}(4 + 11 + 3) \right) = (3, 6)$$

59. (C) Number of diagonals = $\left[\frac{n \times (n - 1)}{2} - n \right] = \left[\frac{8 \times (8 - 1)}{2} - 8 \right]$

$$= 28 - 8 = 20$$

60. (B) ATQ,

$$\text{Cost price of each apple} = \frac{100}{10} = ₹ 10$$

$$\text{Selling price of each apple} = ₹ \left(10 + \frac{25}{100} \times 10 \right) = ₹ 12.5$$

$$\text{Apple sold in ₹ 100} = \frac{100}{12.5} = 8$$

61. (C) To get 25% profit quantity of water mixed in one litre of milk = $1 \times \frac{25}{100} = \frac{1}{4}$

62. (D) Distance covered in 30 minutes by P = $\frac{1}{2} \times 30 = 15$ km

$$\text{Relative speed of P and Q} = 40 - 30 = 10 \text{ km/hr}$$

$$\text{Time taken by Q to overtake P} = \frac{15}{10} = \frac{3}{2} \text{ hours}$$

63. (B) If interest rate is increased by 3% then interest increased = $\frac{800 \times 3 \times 3}{100} = ₹ 72$

$$\text{New amount will be} = ₹ (920 + 72) = ₹ 992$$

64. (B) Radius of circle = $\frac{\sqrt{144+25}}{2} = \frac{13}{2} = 6.5$ cm

65. (A) $\sin \theta \cos \theta = \frac{1}{2}$

$$2 \sin \theta \cos \theta = 1$$

$$\sin 2\theta = 1$$

$$\sin 2\theta = \sin 90^\circ$$

$$\theta = 45^\circ$$

$$\text{Now, } \sin 45^\circ - \cos 45^\circ = \frac{1}{\sqrt{2}} - \frac{1}{\sqrt{2}} = 0$$

66. (B) Correct mean = $40 - \frac{(83-53)}{100}$

$$= 40 - 0.3 = 39.7$$

67. (B) $a^3 + \frac{1}{a^3} = 2$

By adding 6 on both sides,

$$a^3 + \frac{1}{a^3} + 6 = 8$$

$$\left(a + \frac{1}{a} \right)^3 = 8$$

$$a + \frac{1}{a} = \sqrt[3]{8} = 2$$

68. (D) $x \left(3 - \frac{2}{x}\right) = \frac{3}{x}$

$$3x - 2 = \frac{3}{x}$$

$$3x - \frac{3}{x} = 2$$

$$x - \frac{1}{x} = \frac{2}{3}$$

$$x^2 + \frac{1}{x^2} = \frac{4}{9} + 2 = 2\frac{4}{9}$$

69. (C) ATQ,

$$\frac{4}{3} \pi \times 5 \times 5 \times 5$$

$$= \frac{1}{3} \pi \times 5 \times 5 \times h$$

$$h = 20 \text{ cm}$$

70. (C) $P = \frac{(C.I - S.I) \times 100 \times 100}{R^2}$

$$P = \frac{41 \times 100 \times 100}{5 \times 5}$$

$$P = ₹ 16400$$

71. (D) Speed of train = $\frac{10}{12} \times 60 = 50 \text{ km/hr}$

$$\text{New speed} = 50 - 5 = 45 \text{ km/hr}$$

$$\text{New time to over same distance} = 10 \times \frac{60}{45} = \frac{40}{3}$$

72. (A) Expenditure on rent = 25% of ₹ 25000 = $\frac{25}{100} \times 25000$

$$\text{Expenditure on food} = \frac{80}{360} \times 25000$$

$$\text{Required ratio} = \left(\frac{25}{100} \times 25000 : \frac{80}{360} \times 25000 \right) = \frac{25}{100} : \frac{80}{360} = 9 : 8$$

73. (D) Central angle of sector corresponding to expenditure on cloth

$$= \left(\frac{125}{6 \times 100} \times 360 \right) = 75^\circ$$

74. (D) Expenditure on miscellaneous = 12.5%

$$\text{Expenditure on education} = \left(\frac{45^\circ}{360^\circ} \times 100 \right) \% = \frac{25}{2} \% = 12.5\%$$

$$\text{Required \%} = \left(\frac{12.5}{12.5} \times 100 \right) \% = 100\%$$

75. (D) Expenditure on education = $\frac{45}{360} \times 25000 = ₹ 3125$

$$\text{Expenditure on rent} = \frac{25}{100} \times 25000 = ₹ 6250$$

$$\text{Total expenditure} = 3125 + 6250 = ₹ 9375$$

MEANINGS IN ALPHABETICAL ORDER

Adamant	refusing to be persuaded or to change one's mind	जिद्दी
Aftermath	the consequences or after effects of a significant unpleasant event	परिणाम
Anther	the part of a stamen that contains the pollen	पराग-कोश
Apiary	a place where bees are kept; a collection of bee hives	मधुमक्खियों के पालने का स्थान
Aviary	a large cage, building, or enclosure for keeping birds in	चिड़ियाखाना
Comic	causing or meant to cause laughter	हास्यपूर्ण
Coup attempt	an illegal and violent way of an act to a sudden change of government	तख्तापलट के प्रयास
Deed	an action that is performed intentionally or consciously	कार्य
Distraught	extremely upset and anxious so that you cannot think clearly	चिंतित होना, व्यथित होना
Elated	thrilled or delighted	हर्षित, उल्लसित
Heave a sigh	to respire deeply with relief of relief	राहत की सांस लेना
Lullaby	a quiet, gentle song sung to put a child to sleep	लोरी
Oust	drive out or expel (someone) from a position or place	बेदखल करना
Perspicacious	having a ready insight into and understanding of things	तीक्ष्ण-बुद्धि
Ponder	think about (something) carefully before making a decision or reaching a conclusion	गहनता से सोचना
Prevailing	existing at a particular time; current	मौजूदा, वर्तमान
Sentence	declare the punishment decided for (an offender)	सजा देना
Soprano	a singing voice with the highest range for a woman or boy	गाने की ऊँची आवाज
Stumble	trip and almost fall	ठोकर खाना
Summon	authoritatively or urgently call on (someone) to be present, especially as a defendant	बुलावा भेजना
Vanquish	defeat thoroughly	जीत लेना, हरा देना
Vile offence	an offence that is extremely unpleasant	घिनौना अपराध



K D Campus Pvt. Ltd

1997, GROUND FLOOR OPPOSITE MUKHERJEE NAGAR POLICE STATION, OUTRAM LINES, GTB NAGAR, NEW DELHI - 09

SSC MOCK TEST - 268 (ANSWER KEY)

- | | | | |
|---------|---------|---------|----------|
| 1. (B) | 26. (D) | 51. (A) | 76. (C) |
| 2. (B) | 27. (C) | 52. (A) | 77. (B) |
| 3. (D) | 28. (D) | 53. (B) | 78. (B) |
| 4. (D) | 29. (B) | 54. (B) | 79. (D) |
| 5. (B) | 30. (C) | 55. (D) | 80. (B) |
| 6. (C) | 31. (B) | 56. (B) | 81. (D) |
| 7. (D) | 32. (C) | 57. (D) | 82. (A) |
| 8. (A) | 33. (B) | 58. (C) | 83. (D) |
| 9. (A) | 34. (A) | 59. (C) | 84. (A) |
| 10. (B) | 35. (D) | 60. (B) | 85. (C) |
| 11. (D) | 36. (B) | 61. (C) | 86. (D) |
| 12. (A) | 37. (A) | 62. (D) | 87. (C) |
| 13. (D) | 38. (A) | 63. (B) | 88. (A) |
| 14. (D) | 39. (C) | 64. (B) | 89. (C) |
| 15. (B) | 40. (A) | 65. (A) | 90. (C) |
| 16. (B) | 41. (A) | 66. (B) | 91. (A) |
| 17. (C) | 42. (B) | 67. (B) | 92. (B) |
| 18. (A) | 43. (B) | 68. (D) | 93. (A) |
| 19. (D) | 44. (C) | 69. (C) | 94. (A) |
| 20. (A) | 45. (B) | 70. (C) | 95. (A) |
| 21. (C) | 46. (B) | 71. (D) | 96. (D) |
| 22. (C) | 47. (C) | 72. (A) | 97. (D) |
| 23. (C) | 48. (D) | 73. (D) | 98. (D) |
| 24. (D) | 49. (A) | 74. (D) | 99. (D) |
| 25. (C) | 50. (D) | 75. (D) | 100. (D) |

76. (C) Since the subject (i.e, every voter) is singular, it will take singular possessive adjective. Replace 'their' by 'his/her'. Also change 'caste' into 'cast'.
77. (B) The tense of the first part (is - present tense) does not match with the second part (could - past tense), though the sentence refers a past event. Thus, replace 'is' by 'was'.
78. (B) The part of the sentence which starts with 'unless' takes simple present tense. Change 'unless we will qualify' into 'unless we qualify'.
80. (B) When two actions take place in past then earlier one takes past perfect tense and the 2nd one simple present tense.
90. (C) Sentence starting with 'Hardly' takes an inversion form.
91. (A) 'None' takes singular verb after it.
92. (B) Sentence starting with 'only' takes inversion form.